

# **SINGER**

## **246-5**

Form 20448

(151)

Printed in U. S. A.

# LIST OF PARTS



## SINGER\*\*

### MACHINE No. 246-5

---

THE SINGER MANUFACTURING COMPANY

\*\*A Trade Mark of THE SINGER MANUFACTURING COMPANY

From the library of: Diamond Needle Corp

## INSTRUCTIONS FOR OILING

---

To ensure easy running and prevent unnecessary wear of the parts which are in movable contact, the machine requires oiling and when in continuous use, the oil level should be checked daily. The oil level should be maintained at the mid-point of the gauge.

To oil machine, apply "TYPE A" OIL, sold by Singer Sewing Machine Company, to the oil filler cup on top of the machine as instructed in Form 20182.

## INDEX

---

	Page
Accessories.....	20
Belt Guard (Adjustable).....	20
Chip Chute.....	20
Fittings Complete No. 164391.....	19
Foot Lifter Parts.....	21
Machine Base.....	21
Machine No. 246-5.....	7
Numerical List of Parts.....	23
Thread Unwinder No. 151031.....	21

From the library of: Diamond Needle Corp

## INSTRUCTIONS FOR ORDERING

In ordering from this list, use **ONLY** the part NUMBER in the **FIRST** column.

The number stamped on a Sewing Machine Part is in every case the number of the single part only.

Every combination of parts sent out as such has its specific number, which, although not stamped on the parts, must be used when ordering the combination.

Each number always indicates the **SAME PART** in whatever list it appears, or for whatever machine.

The letters after some of the numbers indicate the style of finish only, as follows:

- A—Hardened, Polished, Nickel Plated and Buffed
- A.A—Buffed and Chromium Plated
- A.B—Hardened, Polished, Buffed and Chromium Plated
- A.C—Brown Baking Enamel Finish
- A.D—Gray Baking Enamel Finish
- A.E—Hardened, Bright Rumbled and Nickel Plated
- A.F—Hardened, Bright Rumbled, Nickel Plated, Bright Rumbled and Chromium Plated
- A.G—Alumilite, Plain
- A.H—Alumilite, Dyed
- A.J—Polished, Nickel Plated and Chromium Plated
- A.K—Hardened, Polished, Nickel Plated and Chromium Plated
- A.L—Heat Treated for Toughness
  - B—Polished, Nickel Plated and Buffed
  - C—Hardened Only
- C.R—Hardened and Merlized
- D—Polished Only
- E—Soft, Not Polished
- F—Hardened and Polished
- F.J—Hardened, Polished and Nickel Plated
- G—Bright Rumbled and Nickel Plated
- H—Blued
- J—Nickel Plated Only
- K—Hardened and Nickel Plated
- L—Brass Plated
- M—Oxidized
- N—Japanned, Dull
- P—Japanned, Bright
- P.P—Wrinkle Finish
- R—Merlized
- S—Cadmium Plated
- T—Copper Plated
- T.A—Hardened, Polished, Copper and Nickel Plated and Buffed
- T.B—Copper and Nickel Plated and Polished
- T.J—Copper and Nickel Plated Only
- T.K—Hardened, Copper and Nickel Plated
- T.L—Copper and Brass Plated
- T.M—Copper Plated and Oxidized

## INSTRUCTIONS FOR ORDERING—Continued

- U—Zinc Plated
- V—Silver Plated
- W—Polished and Nickel Plated
- X—Black Oxide, for Iron and Steel
- X.C—Hardened and Black Oxide, for Iron or Steel
- Y—Black Nickel Plated Only
- Z—Chromium Plated
- Z.A—Hardened, Polished, Nickel Plated, Buffed and Chromium Plated
- Z.B—Polished, Nickel Plated, Buffed and Chromium Plated
- Z.C—Hardened and Chromium Plated
- Z.D—Polished and Chromium Plated
- Z.G—Bright Rumbled, Nickel Plated, Bright Rumbled and Chromium Plated
- Z.J—Nickel and Chromium Plated
- Z.T—Copper and Chromium Plated

These letters **MUST BE USED** when they appear in the list; and **AFTER** the number as in the list.

In this series:

1 to 1500, 50001 to 51500 and 140001 to 142000 are Screw Numbers

1501 to 1800 and 51501 to 51800 are Nut Numbers

1801 to 2000 and 51801 to 52000 are Roller Numbers

2001 to 50000 and 52001 to 140000 and 142001 to 190000 are Sewing Machine Parts, 190001 and upward are numbers of Electrical Parts.

The figures in the second column refer only to the plates, illustrating the parts, and are **NOT TO BE USED** in ordering.

Parts marked with an asterisk (\*) are furnished only when repairs are made at factory.

From the Library of: Singer Sewing Machine Corp

**SINGER** Needles should be used  
in **SINGER** Machines  
These Needles and their Containers  
are marked with the  
Company's Trade Mark "SIMANCO.\*\*\*"

Needles in Containers marked  
"FOR SINGER MACHINES"  
are **NOT SINGER** made needles.

LIST OF PARTS COMPLETE  
FOR

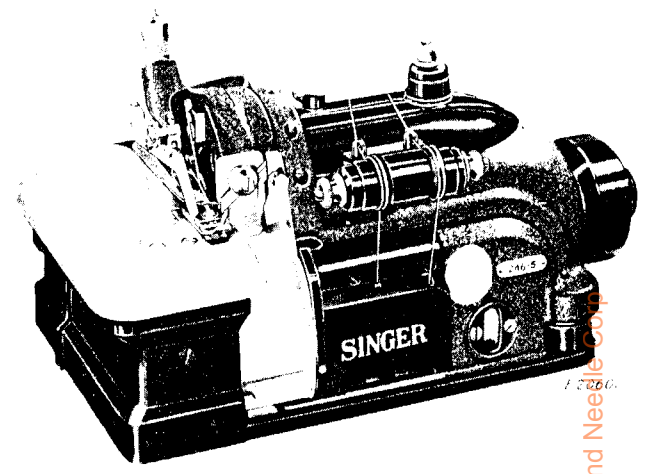

SINGER Needles should be used  
in SINGER Machines  
These Needles and their Containers  
are marked with the  
Company's Trade Mark "SIMANCO.\*\*" 1

Needles in Containers marked  
"FOR SINGER MACHINES"  
are NOT SINGER made needles. 2

MACHINE No. 246-5

FOR TRIMMING AND OVEREDGING MEDIUM  
HEAVY AND HEAVY WEIGHT FABRICS.  
ONE NEEDLE. TWO LOOPERS.  
GATHERING FEED. TRIMMER.  
SPEED UP TO 5000 R. P. M., DEPENDING ON MATERIALS

USED AND OPERATIONS PERFORMED.

No.	Plate	Name
164001	24767	Chip Guard.....
1209J	24767	" " Screw (lower).....
140509J	24767	" " " (upper).....
164107	24767	Cloth Plate.....
164002	24767	" " Extension.....
914J	24767	" " " Screw (?)...
1700J	24767	" " " Nut...
164205	24767	" " Lock Spring.....
1700J	24767	" " " Nut.....
1250AL	24767	" " " " Screw Stud
164104	24767	" " Plunger.....
164105	24767	" " " Spring.....

From the library of: Diamond Needle Corp.

No.	Plate	Name
624AL	24767	Cloth Plate Plunger Set Screw.....
164106	24767	" " Position Collar with two 624AL.....
624AL	24767	Cloth Plate Position Collar Set Screw (2).....
164108	24767	Cloth Plate with Extension com- plete, Nos. 164002, 164107, 164205 and two each 914J and 1700J.....
164003	24789	Feed Bar Hinge Pin (eccentric)....
1389C	24789	" " " " Set Screw.....
164004	24789	" " Slide Block (back) (2)...
1628C	24789	" " " " " Nut...
17022	24789	" " " " " Washer.....
164366	24789	Feed Bar Slide Block (front).....
164016	24789	" (back) Bar with 164010.....
164017	24789	" " " " Connection.....
164008	24789	" " " " " Bearing
164009	24789	" " " " " Hinge Screw Stud.....
1671C	24789	Feed (back) Bar Connection Hinge Screw Stud Nut.....
164010	24789	Feed (back) Bar Connection Hinge Screw Stud Nut Position Pin...
164367	24794	Feed (back) Dog Section (left)....
164223	24794	" " " " " (right)...
1100AL	24794	" " " " " Screw.....
164369	24794	Feed (back) Dog complete, Nos. 1100AL, 164223 and 164367.....
1454F	24794	Feed (back) Dog Screw.....
164020	24789	" " Eccentric.....
Note:		Feed (back) Eccentric No. 164020 is furnished in 6 to 16, 18, 20, 22, 24, 28, 32 and 36 stitches to the inch, unless otherwise stated No. 164020 (14 stitches to the inch) is supplied regularly.
164006	24789	Feed (front) Bar with 164010.....
164007	24789	" " " " Connection.....
164018	24789	" " " " " Bear- ing.....
164009	24789	Feed (front) Bar Connection Hinge Screw Stud.....
1671C	24789	Feed (front) Bar Connection Hinge Screw Stud Nut.....
164010	24789	Feed (front) Bar Connection Hinge Screw Stud Nut Position Pin...
164370	-----	Feed (back) and (front) Bars com- plete, Nos. 164006, 164007, 164008, 164016, 164017, 164018, 164366 and two each 1671C, 164004 and 164009.....
164371	24794	Feed (front) Dog.....
1454F	24794	" " " " Screw.....

No.	Plate	Name
164020	24789	Feed (front) Eccentric.....
Note:		Feed (front) Eccentric No. 164020 is furnished in 6 to 16, 18, 20, 22, 24, 28, 32 and 36 stitches to the inch, unless otherwise stated No. 164020 (14 stitches to the inch) is supplied regularly.
164398	24789	Feed Eccentric Cover.....
164399	24789	" " " " Bracket.....
157C	24789	" " " " " Screw
629K	24789	" " " " " Hinge Screw..
164401	24789	" " " " " Latch Spring.
227J	24789	" " " " " " " Screw (2).....
164402	24789	Feed Eccentric Cover complete, Nos. 629K, 164023, 164398, 164399, 164401 and two 227J...
164023	24789	Feed Eccentric Oil Wick.....
164372	24790	" Lifting and Knife (movable) Lever Eccentric.....
164455	24793	Finger Guard.....
164456	24793	" " " " Adaptor.....
1259AL	24793	" " " " " Screw.....
1423J	24793	" " " " " Screw.....
164308	24791	Knife (movable) (2).....
164027	24791	" " " " " Clamp.....
140050C	24791	" " " " " Screw.....
164028	24791	" " " " " Guard (lower)....
164458	24791	" " " " " (upper).....
164029	24791	" " " " " Holder.....
198J	24791	" " " " " Screw.....
164030	24791	" " " " " " " Bear- ing.....
164031	24791	Knife (movable) Lever with 620AL..
164211	-----	" " " " " 164031 with 132583, 164035, 164136 and 164153.....
164032	24791	Knife (movable) Lever Bearing....
50421AL	24791	" " " " " " " Set Screw (long).....
624AL	24791	Knife (movable) Lever Bearing Set Screw (short).....
164373	24793	Knife (movable) Lever Cover and Presser Bar (upright) Housing with 1259AL.....
50073J	24793	Knife (movable) Lever Cover and Presser Bar (upright) Housing Screw (2).....
164374	-----	Knife (movable) Lever Cover and Presser Bar (upright) Housing complete, Nos. 50060K, 164137, 164138, 164139, 164142, 164143, 164144, 164194 and 164373.....
164180	24791	Knife (movable) Lever Guide.....
164181	24791	" " " " " " " Holder with two 140239AL.....

Copyright © 2013 by The Library of The University of Toronto

No.	Plate	Name
164210	24791	Knife (movable) Lever Guide Holder 164181 with 197J, 164177, 164180 and 164182.....
140239AL	24791	Knife (movable) Lever Guide Holder Set Screw (2).....
164182	24791	Knife (movable) Lever Guide Holder Thread Tube.....
50421AL	24791	Knife (movable) Lever Guide Holder Thread Tube Set Screw.....
197J	24791	Knife (movable) Lever Guide Screw.
132583	24791	" " " Hinge Pin with 132584.....
132584	24791	Knife (movable) Lever Hinge Pin Oil Wick.....
620AL	24791	Knife (movable) Lever Hinge Pin Set Screw.....
164034	24791	Knife (movable) Lever Hinge Stud..
164035	-----	" " " " " 164034 with 164036 and 164269.
164036	24791	Knife (movable) Lever Hinge Stud Oil Wick (long).....
164269	-----	Knife (movable) Lever Hinge Stud Oil Wick (short).....
50421AL	24791	Knife (movable) Lever Hinge Stud Set Screw (back).....
1143AL	24791	Knife (movable) Lever Hinge Stud Set Screw (top).....
164233	24791	Knife (stationary) (2).....
164038	24791	" " " Clamping Stud..
51715AL	24791	" " " " " Nut.....
164039	24791	Knife (stationary) Holder.....
164040	24791	" " " Adjust- ing Stud.....
1454E	24791	Knife (stationary) Holder Adjust- ing Stud Cap Screw.....
39541	24791	Knife (stationary) Holder Adjust- ing Stud Cap Screw Washer.....
164041	24791	Knife (stationary) Holder Cap.....
164042	24791	" " " Sleeve..
140088R	24791	" " " " " Screw.....
59456	24791	Knife (stationary) Holder Sleeve Screw Washer.....
164043	24791	Knife (stationary) Holder Spring..
164044	24791	" " " " " Retainer.....
1454J	24791	Knife (stationary) Holder Spring Retainer Screw.....
164462	24791	Lint Stripper with 735AL.....
735AL	24791	" " " Set Screw.....
164045	24792	Looper (left hand).....
164046	24792	" " " Carrier with 460AL, 50379F and 164202.....
164047	24792	Looper (left hand) Carrier Holder with two 140393AL.....

No.	Plate	Name
164212	-----	Looper (left hand) Carrier Holder 164047 with 1324C, 59456 and 164046.....
140393AL	24792	Looper (left hand) Carrier Holder Set Screw (2).....
1324C	24792	Looper (left hand) Carrier Screw..
460AL	24792	" " " " " Set Screw.....
59456	24792	Looper (left hand) Carrier Screw Washer.....
164048	24792	Looper (left hand) Driving Shaft..
164049	24792	" " " " " Bushing (back).....
140394E	24792	Looper (left hand) Driving Shaft Bushing (back) Cap Screw.....
164293	24792	Looper (left hand) Driving Shaft Bushing (back) Cap Screw Wash- er.....
164050	24792	Looper (left hand) Driving Shaft Bushing (front).....
164051	24792	Looper (left hand) Driving Shaft Crank with 1083C.....
164215	-----	Looper (left hand) Driving Shaft Crank 164051 with 164052.....
1083C	24792	Looper (left hand) Driving Shaft Crank Clamping Screw.....
164052	24790	Looper (left hand) Driving Shaft Crank Connection with two each 171AL and 140159AL.....
171AL	24790	Looper (left hand) Driving Shaft Crank Connection Cap (lower) Screw (2).....
140159AL	24790	Looper (left hand) Driving Shaft Crank Connection Cap (upper) Screw (2).....
164067	24792	Looper (left hand) Driving Shaft Crank Key.....
1324C	24792	Looper (left hand) Driving Shaft Crank Key Screw.....
45057	24792	Looper (left hand) Driving Shaft Crank Key Screw Washer.....
164053	24792	Looper (left hand) Driving Shaft Crank Thrust Bearing.....
50379F	24792	Looper (left hand) Set Screw.....
164202	24792	" " " Stop Pin.....
164054	24794	" " " Thread Tube....
853AL	24794	" " " " " Set Screw.....
164375	24792	Looper (right hand).....
164056	24792	" " " Carrier with 50370E.....
164057	24792	Looper (right hand) Carrier Con- nection.....
164058	24792	Looper (right hand) Carrier Con- nection Guide Bar with 624AL and 168215.....

No.	Plate	Name
168215	-----	Looper (right hand) Carrier Connection Guide Bar Oil Wick....
624AL	24792	Looper (right hand) Carrier Connection Guide Bar Plug Screw..
164463	24792	Looper (right hand) Carrier Connection Guide Bar Bracket with 164060 and two 462AL.....
164060	24792	Looper (right hand) Carrier Connection Guide Bar Bracket Oil Pad.....
914C	24792	Looper (right hand) Carrier Connection Guide Bar Bracket Screw (left).....
1057AL	24792	Looper (right hand) Carrier Connection Guide Bar Bracket Screw (right).....
462AL	24792	Looper (right hand) Carrier Connection Guide Bar Set Screw (2).....
164061	24792	Looper (right hand) Carrier Connection Hinge Stud with 1019AL
1443J	24792	Looper (right hand) Carrier Connection Hinge Stud Cap Screw..
164397	24792	Looper (right hand) Carrier Connection Hinge Stud Adjusting Pin.....
1019AL	24792	Looper (right hand) Carrier Connection Hinge Stud Adjusting Pin Set Screw.....
132565	24792	Looper (right hand) Carrier Hinge Pin.....
50370E	24792	Looper (right hand) Carrier Hinge Pin Set Screw.....
164062	24792	Looper (right hand) Driving Lever with 1083C and two 140393AL...
164464	-----	Looper (right hand) Driving Lever 164062 with 1443J, 1700J, 132565, 164056, 164057, 164058, 164061, 164068, 164397 and 164463.....
1083C	24792	Looper (right hand) Driving Lever Clamping Screw.....
140393AL	24792	Looper (right hand) Driving Lever Set Screw (2).....
164063	24792	Looper (right hand) Driving Shaft.
164049	24792	" " " " "
		Bushing (back).....
140394E	24792	Looper (right hand) Driving Shaft Bushing (back) Cap Screw.....
164293	24792	Looper (right hand) Driving Shaft Bushing (back) Cap Screw Washer (fiber).....
164065	24792	Looper (right hand) Driving Shaft Bushing (front).....
164066	24792	Looper (right hand) Driving Shaft Crank with 1083C.....

No.	Plate	Name
164216	-----	Looper (right hand) Driving Shaft Crank 164066 with 164052.....
1083C	24792	Looper (right hand) Driving Shaft Crank Clamping Screw.....
164052	24730	Looper (right hand) Driving Shaft Crank Connection with two each 171AL and 140159AL.....
171AL	24790	Looper (right hand) Driving Shaft Crank Connection Cap (lower) Screw (2).....
140159AL	24790	Looper (right hand) Driving Shaft Crank Connection Cap (upper) Screw (2).....
164067	24792	Looper (right hand) Driving Shaft Crank Key.....
1324C	24792	Looper (right hand) Driving Shaft Crank Key Screw.....
45057	24792	Looper (right hand) Driving Shaft Crank Key Screw Washer.....
164053	24792	Looper (right hand) Driving Shaft Crank Thrust Bearing.....
164068	24792	Looper (right hand) Locking Screw Stud.....
1700J	24792	Looper (right hand) Locking Screw Stud Nut.....
164219	24792	Looper (right hand) Position Collar with 904E.....
904E	24792	Looper (right hand) Position Collar Set Screw.....
*164072	-----	Machine Frame.....
*164073	-----	Machine Frame complete, Nos. 45773, 140396E, 164072, 164077, 164218, two 15405 and three 140395C.....
164074	24756	Machine Frame Bottom Cover.....
164075	24756	" " " " Gasket.
914C	24756	" " " " Screw (13).....
*164076	-----	Machine Frame Bracket.....
*164218	-----	" " " " 164076 with 164207 and two 187E.....
164207	24759	Machine Frame Bracket Key.....
187E	24759	" " " " Screw (2).....
140396E	24759	Machine Frame Bracket Screw (large).....
164077	24759	Machine Frame Bracket Screw (large) Washer (fiber).....
164229	24759	Machine Frame Bracket Screw (large) Washer (felt).....
140395C	24759	Machine Frame Bracket Screw (small) (3).....
164078	24756	Machine Frame Cover (back).....
50571J	24756	" " " " Screw (long) (2).....
914J	24756	Machine Frame Cover (back) Screw (short).....



No.	Plate	Name
164079	24756	Machine Frame Cover (back) Slide..
140200J	24756	" " " " " "
		Position Screw.....
238J	24756	Machine Frame Cover (back) Slide
		Stop Screw.....
164080	24756	Machine Frame Cover (back) com- plete, Nos. 238J, 1637K, 140200J, 140228C, 164078 and 164079.....
164081	24759	Machine Frame Oil Lead.....
140088R	24759	" " " " Screw.....
1698J	24759	" " " " " Nut..
164082	24759	" " " " Plug Bracket....
1036AL	24759	" " " " " Set Screw.....
51285E	24759	Machine Frame Oil Plug Screw.....
164313	24759	" " " " " Wash- er (steel).....
164314	24759	Machine Frame Oil Plug Screw Wash- er (cork).....
164083	24759	Machine Frame Oil Screen.....
206J	24759	" " " " " Screw (3)
164084	24759	" " " " " Splash Guard (internal).....
164085	24793	Machine Frame Oil Splash Guard (top).....
51023W	24793	Machine Frame Oil Splash Guard (top) Screw (2).....
164086	24759	Machine Frame Oil Tube with 164087
50421AL	24759	" " " " " Set Screw..
164087	24759	" " " " " Wick.....
164461	-----	" " " " " Re- tainer.....
164088	24790	Machine Frame Plug.....
164376	24790	" " " " Rotary Shaft.....
164377	-----	" " " " " 164376 with 164097, 164215, 164216, 164217 and two each 164093 and 164232.....
139026	24790	Machine Frame Rotary Shaft Ball Bearing.....
164092	24790	Machine Frame Rotary Shaft Ball Bearing Housing.....
51369C	24790	Machine Frame Rotary Shaft Ball Bearing Housing Screw (3).....
164093	24790	Machine Frame Rotary Shaft Ball Sleeve (two pieces) (2).....
164232	24790	Machine Frame Rotary Shaft Ball Sleeve Guide (2).....
164094	24790	Machine Frame Rotary Shaft Bushing (front).....
1036AL	24790	Machine Frame Rotary Shaft Bushing (front) Set Screw.....
164095	24790	Machine Frame Rotary Shaft Bushing (intermediate).....
51332C	24790	Machine Frame Rotary Shaft Bushing (intermediate) Set Screw.....

No.	Plate	Name
164096	24790	Machine Frame Rotary Shaft Coun- terbalance with 1036AL.....
1036AL	24790	Machine Frame Rotary Shaft Coun- terbalance Set Screw.....
164097	24790	Machine Frame Rotary Shaft Key....
51649C	24790	" " " " " Nut....
131056	24790	" " " " " " Washer.....
164098	24790	Machine Frame Rotary Shaft Oil and Ball Bearing Grease Retainer..
164099	24790	Machine Frame Rotary Shaft Screw Stud.....
164100	24790	Machine Frame Rotary Shaft Thrust Bearing.....
164101	24772	Machine Frame Top Cover.....
164214	-----	" " " " " 164101 with 330J, 164103 and two 164418.....
164102	24772	Machine Frame Top Cover Gaske....
164103	24772	" " " " " Oil Lead..
330J	24772	" " " " " " Screw.....
51369J	24772	Machine Frame Top Cover Screw (3)..
164231	24790	" Pulley (round and "V" belt) with two 448AL.....
164071	24790	Machine Pulley Cap.....
140416X	24790	" " " " " Screw.....
448AL	24790	" " " " " Set Screw (2)....
164109	24793	Needle Clamp.....
51720C	24793	" Clamping Nut.....
164110	24793	" Driving Shaft with 164108..
164275	-----	" " " " 164110 with 51720C, 164109 and 164117....
164111	24793	Needle Driving Shaft Bushing....
164112	24793	" " " " " Cap..
164113	24793	" " " " " (1 Lead.....
452C	24793	Needle Driving Shaft Bushing Oil Lead Hole Plug Screw.....
164114	24793	Needle Driving Shaft Crank with 1083C and two 140393AL.....
164115	24793	Needle Driving Shaft Crank Ball...
1083C	24793	" " " " " Clamp- ing Screw.....
164116	24790	Needle Driving Shaft Crank Connec- tion with two each 171AL and 140159AL.....
164217	-----	Needle Driving Shaft Crank Connec- tion 164116 with 164115.....
140159AL	24790	Needle Driving Shaft Crank Connec- tion Cap (lower) Screw (2)....
171AL	24790	Needle Driving Shaft Crank Connec- tion Cap (upper) Screw (2)....
140393AL	24793	Needle Driving Shaft Crank Set Screw (2).....
164117	24793	Needle Holder.....

Copyright © 2011 by Diamond Needle Corp.

No.	Plate	Name
164118	24793	Needle Stop Pin.....
164119	24790	Oil Agitator.....
164120	24759	" Cooler with two 164125.....
164121	24759	" " Cover.....
164123	24759	" " " 164121 with 164135.....
164122	24759	Oil Cooler Cover Gasket.....
145J	24759	" " " Screw.....
164124	24759	" " Gasket.....
164125	24759	" " Oil Pipe (outlet) (2)..
164126	24759	" " " Tube with 138269 and 164128.....
164127	24759	Oil Cooler Oil Tube Coupling.....
51630	24759	" " " " Lock Nut.....
138269	24759	" " " " Sleeve.....
164128	24759	" " " " Wick.....
51139J	24759	" " " Screw (long) (2).....
1324J	24759	" " " (short).....
164131	24759	" Sight Gauge Background Disc...
164132	24759	" " " " " "
		Gasket.....
164133	24759	Oil Sight Gauge Window.....
164132	24759	" " " " Gasket.....
164134	24759	" " " " Retainer...
164132	24759	" " " " " "
		Gasket.....
1485J	24759	Oil Sight Gauge Window Retainer Screw (2).....
164135	24759	Oil Cup for filling machine.....
164136	24791	Presser Bar Bracket.....
164137	24793	" " Lifting Bracket with 462AL, 624AL and 51846.....
51846	24793	Presser Bar Lifting Bracket Roller and Stud.....
624AL	24793	Presser Bar Lifting Bracket Set Screw (long).....
462AL	24793	Presser Bar Lifting Bracket Set Screw (short).....
164138	24793	Presser Bar Lifting Lever.....
164139	24793	" " " " Spring..
140228C	24756	" " " " Stop Screw.....
1637K	24756	Presser Bar Lifting Lever Stop Screw Nut.....
164350	24791	Presser Bar (swing-out).....
164141	24791	" " " Lifting Screw Stud.....
1700J	24791	Presser Bar (swing-out) Lifting Screw Stud Nut.....
164142	24793	Presser Bar (swing-out) Opening Lever.....
50060K	24793	Presser Bar (swing-out) Opening Lever Hinge Screw.....
140510C	24791	Presser Bar (swing-out) Pivot Screw.....
164351	24791	Presser Bar (swing-out) Pivot Screw Lock Washer.....

No.	Plate	Name
51362AL	24791	Presser Bar (swing-out) Pivot Screw Lock Washer Screw.....
164143	24793	Presser Bar (upright).....
164144	24793	" " " Spring.....
164378	24794	" Foot Body.....
164379	24794	" " Chaining-off Finger..
164147	24794	" " Clamping Plate.....
50225J	24794	" " " Screw..
164360	24794	" " Guide.....
50169J	24794	" " " Screw.....
164380	24794	Presser Foot complete, Nos. 50169J, 50225J, 164147, 164360, 164378 and 164379.....
164194	24793	Pressure Regulating Thumb Screw...
2102	24772	Tension (heavy) Disc (4).....
164155	24772	" " " Regulating Thumb Nut (2).....
50133C	24772	Tension (heavy) Screw Stud (2)....
164156	-----	" " " " 50133C with 164155 (2).....
164161	24772	Tension (heavy) Spring (2).....
59537	24772	" " " Bushing (2)
164158	24772	" " " " Cover (2)..
164162	24772	Tension (heavy) complete, Nos. 59537, 164156, 164158, 164161 and two 2102 (2).....
2102	24772	Tension (light) Disc (2).....
164155	24772	" " " Regulating Thumb Nut.....
50133C	24772	Tension (light) Screw Stud.....
164156	-----	" " " " 50133C with 164155.....
164157	24772	Tension (light) Spring.....
59537	24772	" " " Bushing....
164158	24772	" " " " Cover.....
164160	24772	Tension (light) complete, Nos. 59537, 164156, 164157, 164158 and two 2102.....
164285	24772	Tension (looper thread) Thread Guide (left).....
164286	24772	Tension (looper thread) Thread Guide (right).....
164159	24772	Tension (needle thread) Thread Guide.....
164418	24772	Tension Thread Eyelet (2).....
164091	24792	Thread (looper, right hand) Strip- per and Take-up.....
164163	24761	Thread (looper, right hand) Strip- per and Take-up Eyelet (adjustable).....
1443J	24761	Thread (looper, right hand) Strip- per and Take-up Eyelet (adjustable) Screw.....
187E	24792	Thread (looper, right hand) Strip- per and Take-up Screw.....
17022	24792	Thread (looper, right hand) Strip- per and Take-up Screw Washer..

No.	Plate	Name
164164	24761	Thread (looper, right hand) Thread Eyelet (movable).....
1423J	24761	Thread (looper, right hand) Thread Eyelet Screw.....
164165	24761	Thread (looper, right hand) Thread Eyelet (stationary).....
1607J	24761	Thread (looper, right hand) Thread Eyelet (stationary) Nut.....
164166	24761	Thread (looper, right hand) Tube..
624AL	24761	" " " " " "
		Set Screw.....
164167	24761	Thread (looper) Plate with 624AL..
164168	24761	" " " Cover.....
164206	-----	" " " " 164168 with 164169 and 164170.....
164169	24761	Thread (looper) Plate Cover Hinge..
164170	24761	" " " " " "
		Pin.....
164171	24761	Thread (looper) Plate Cover Spring (2).....
332J	24761	Thread (looper) Plate Cover Spring Screw (2).....
896AL	24761	Thread (looper) Plate Cover Spring Thread Bushing Screw (2).....
164173	24761	Thread (looper) Plate Thread Bushing.....
50318W	24761	Thread (looper) Plate Thread Bushing Screw.....
164174	-----	Thread (looper) Plate complete, Nos. 1423J, 1443J, 1607J, 50318W, 164163, 164164, 164165, 164166, 164167, 164173, 164206 and two each 332J and 164171.....
164175	24792	Thread (looper) Take-up.....
164175	24792	" " " Plate.....
176E	24792	" " " Screw (lower).....
1443W	24792	Thread (looper) Take-up Screw (upper).....
164151	24791	Thread (needle) Controller.....
164153	24791	" " " Lever..
1443B	24791	" " " Screw (2).....
164177	24791	Thread Eyelet (needle thread).....
140239AL	24791	" " " " Set Screw.....
164227	24794	Throat Plate.....
164179	24794	" " Guide with 853AL.....
1454E	24794	" " " Screw.....
1094F	24794	" " " Screw (2).....
*45773	-----	Trade Mark.....
15405	-----	" " Rivet (2).....

## SET OF FITTINGS COMPLETE

### No. 164391 FOR SWEATER MATERIAL

### FOR THREE-THREAD STITCH

NOTE: SET OF FITTINGS No. 164391 IS REGULAR TO MACHINE, UNLESS OTHERWISE STATED ON MACHINE ORDER.

No.	Plate	Name
164367	24795	Feed (back) Dog Section (left)....
164223	24795	" " " " (right)...
1100AL	24795	" " " " " "
		Screw.....
164369	24795	Feed (back) Dog complete, Nos. 1100AL, 164223 and 164367.....
164371	24795	Feed (front) Dog.....
164308	24795	Knife (movable).....
164375	24795	Looper (right hand).....
164350	24795	Presser Bar (swing-out).....
164378	24795	" Foot Body.....
164379	24795	" " Chaining-off Finger..
164147	24795	" " Clamping Plate.....
50225J	24795	" " " " Screw.
164360	24795	" " Guide.....
50169J	24795	" " " Screw.....
164380	24795	Presser Foot complete, Nos. 50169J, 50225J, 164147, 164360, 164378 and 164379.....
164175	24795	Thread (looper) Take-up (left)....
164091	24795	" " " " (right)...
164151	24795	" (needle) Controller.....
164227	24795	Throat Plate.....
164179	24795	" " Guide with 853AL.....
164391	24795	Set of Fittings complete, Nos. 164091, 164151, 164175, 164179, 164227, 164308, 164350, 164369, 164371, 164375 and 164380.....

## ACCESSORIES

No.	Plate	Name
160577	24796	Container of Oil (15 ozs.).....
164203	24796	Feed Eccentric Extractor (not regularly furnished).....
164460	24796	Gauge.....
120344	24796	Oiler (copper plated) with 120345.
120345	24796	" Spout, 4 1/2 in. long.....
164198	24796	Presser Bar Lifting Chain Spring (under table).....
26026	24796	Screw Driver.....
164196	24796	Threader (6).....
164204	24796	Tweezers.....
164197	24796	Wrench (socket).....
8908	24796	" (flat).....

## BELT GUARD (Adjustable)

No.	Plate	Name
164183	24763	Belt Guard.....
164199	24763	" " Bracket (back).....
164200	24763	" " " (front).....
51326J	24763	" " Screw (2).....
164201	24763	Belt Guard (adjustable) complete, Nos. 164183, 164199, 164200 and two each 51326J and wood screws 3/4 in. No. 7 F.H.....

## CHIP CHUTE

No.	Plate	Name
168198	24763	Chip Chute with four wood screws 3/8 in. No. 6 R.H. blacked....

## FOOT LIFTER PARTS

No.	Plate	Name
6439	24763	Chain, 36 in. to 45 in. with 56864 and 56865.....
Note: When ordering No. 6439, give length required.		
4879	24763	Chain Connecting Link.....
56864	24763	" Hook (large).....
56865	24763	" " (small).....
4881	24763	Treadle.....
4882	24763	" Shaft.....
4883	-----	" Spring.....
4884	24763	" Stand.....
4885	24763	Treadle complete, Nos. 4979, 4881, 4882, 4883, 4884 and two wood screws 1 in. No. 16 F.H.....

## MACHINE BASE

No.	Plate	Name
164184	24763	Machine Base with 50608R, 139017 and two each wood screws 3/4 in. No. 8 R.H. and 1 1/4 in. No. 6 F.H.....
50608R	24763	Machine Base Plug Screw.....
139017	24763	" " " " Washer... ..
164188	24763	" Cushion (large) (2).....
164189	24763	" " (small) (2).....
164190	24763	" Pad (felt).....
140418E	24790	" Screw Stud (back).....
657E	24790	" " " (front).....

## THREAD UNWINDER No. 151031

FOR

THREE SPOOLS

No.	Plate	Name
151023	24764	Spool Rest with 858AL.....
150203	24764	" " Cushion (felt) (3).....
858AL	24764	" " Hub Set Screw.....
151024	24764	" " Rod.....
1122C	24764	" " " Set Screw (2).....

From the library of Diamond Needle Co.

THREAD UNWINDER

24756 - 1/3

No.	Plate	Name
151025	24764	Spool Rest Stand with two 1122C and three wood screws 1 in. No. 12 F.H.....
151026	24764	Thread Guide (lower).....
50311C	24764	" " " Holder Set Screw.....
151027	24764	Thread Guide (lower) Support with 50311C.....
151028	24764	Thread Guide (upper) (2).....
151029	24764	" " " Holder with four 453AL.....
453AL	24764	Thread Guide Set Screw (3).....
151030	24764	" " Rod.....
453AL	24764	" " " Set Screw.....
151031	24764	Thread Unwinder complete, Nos. 151023, 151024, 151025, 151026, 151027, 151029, 151030, two 151028 and three 150203.....

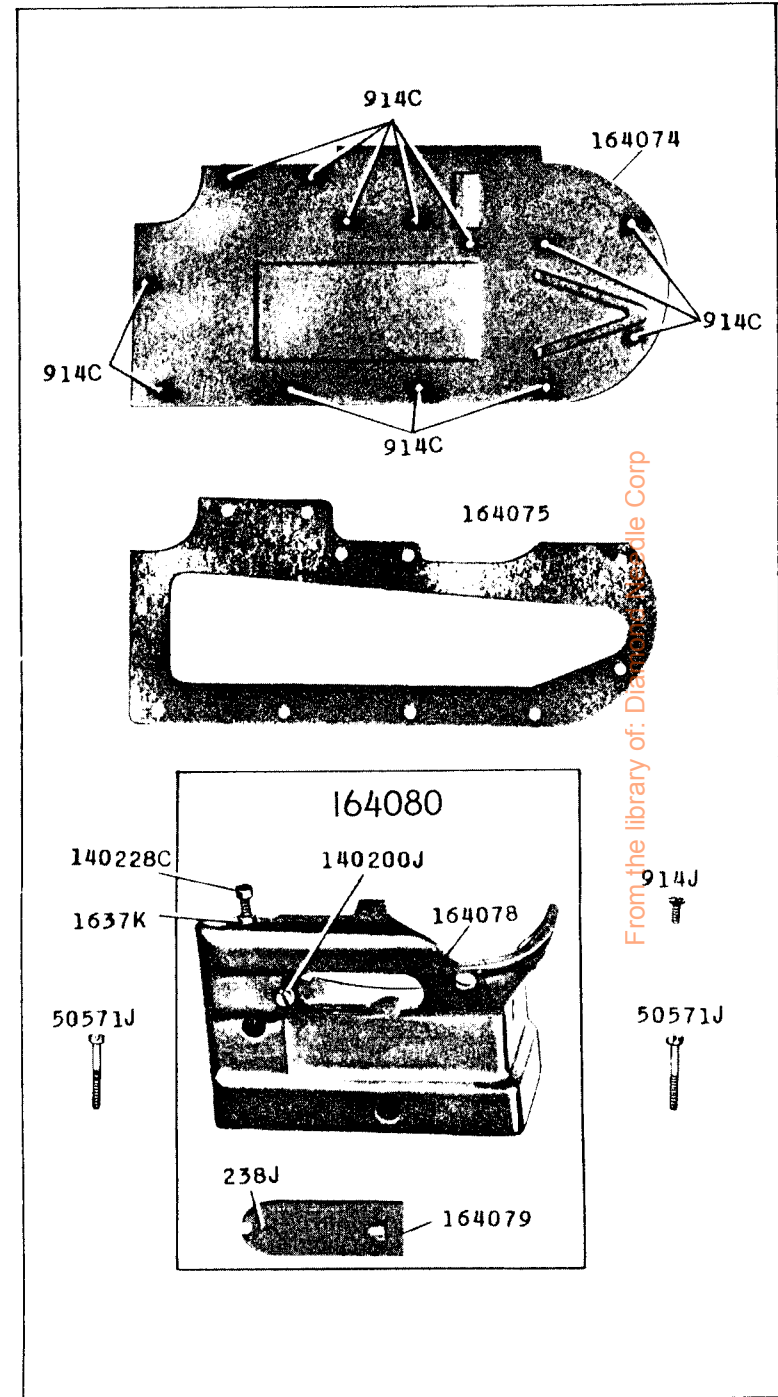

24759 - 1/3

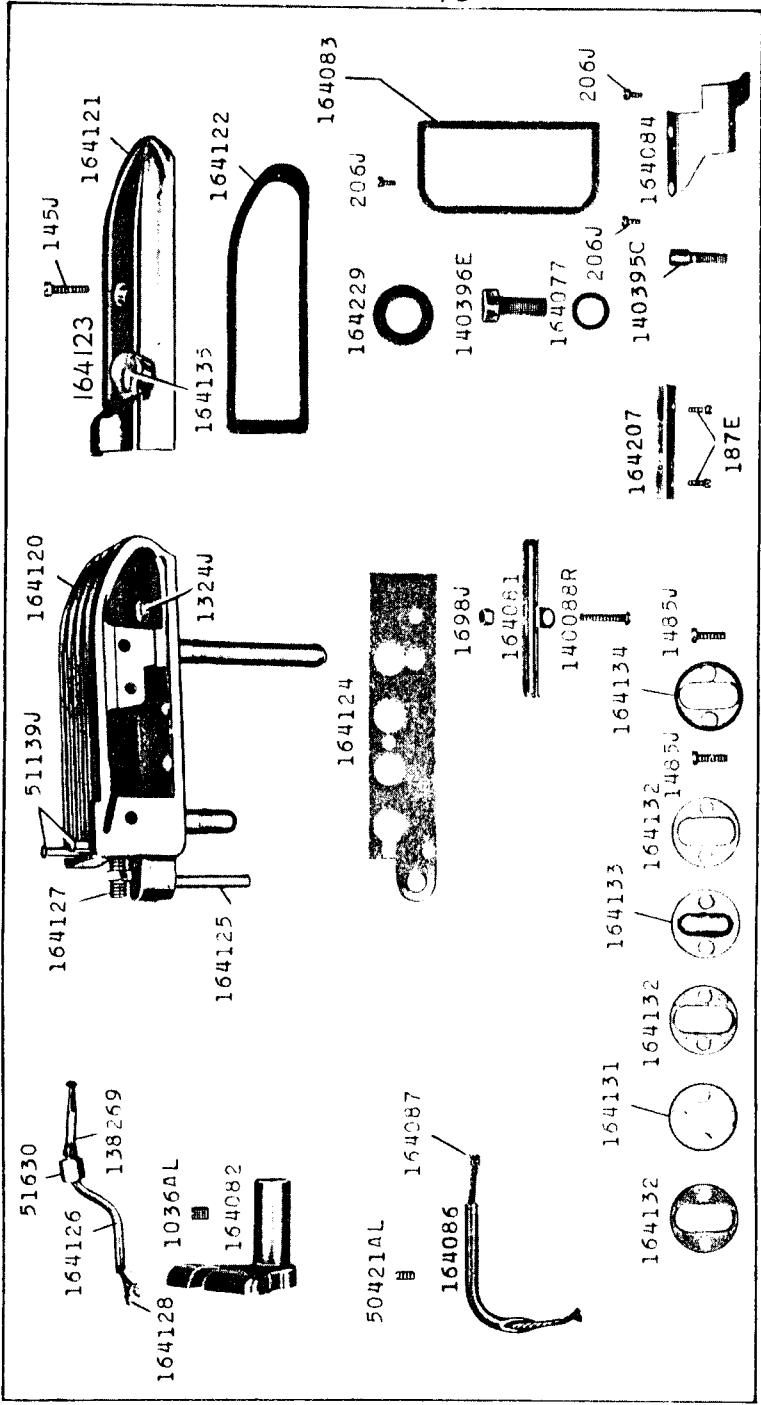

24761 - 2/3

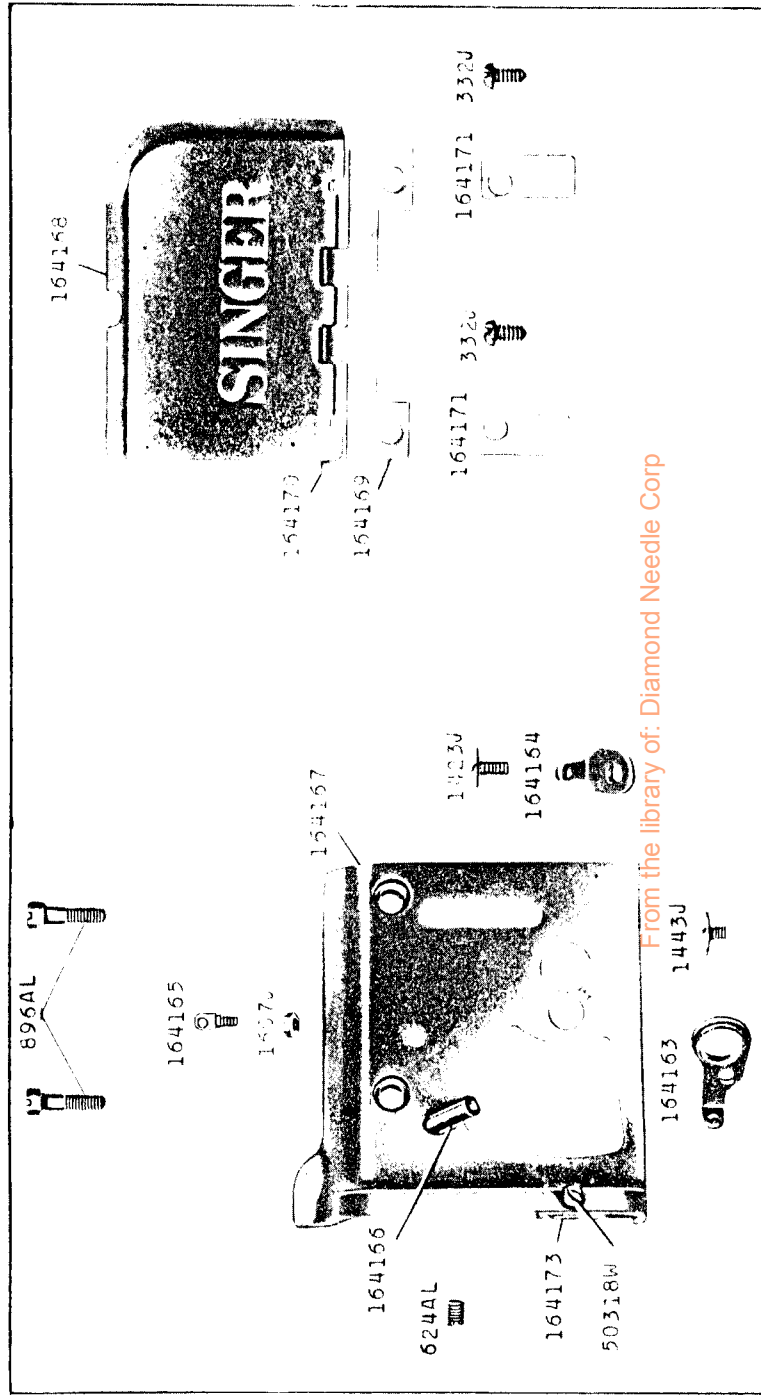

From the library of: Diamond Needle Corp

24763 - 1/4

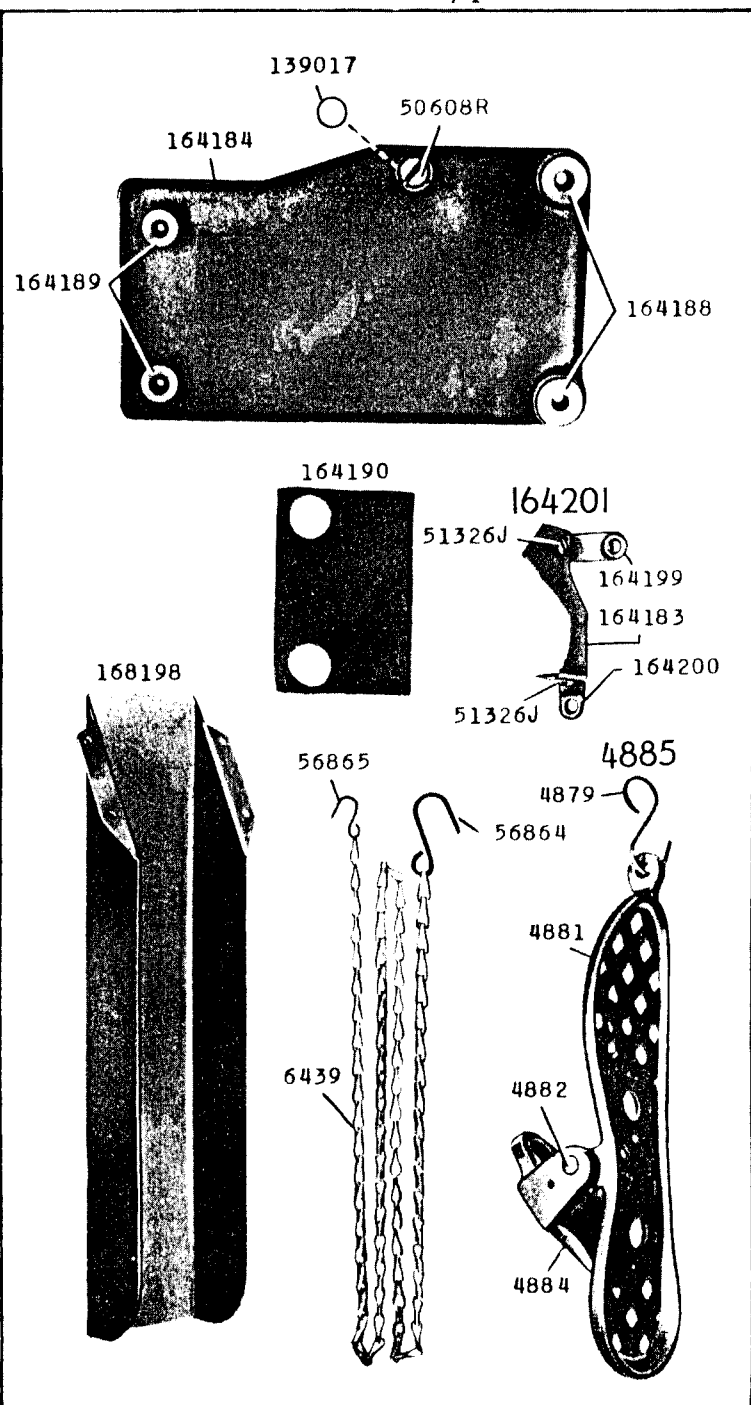

24764 - 1/6

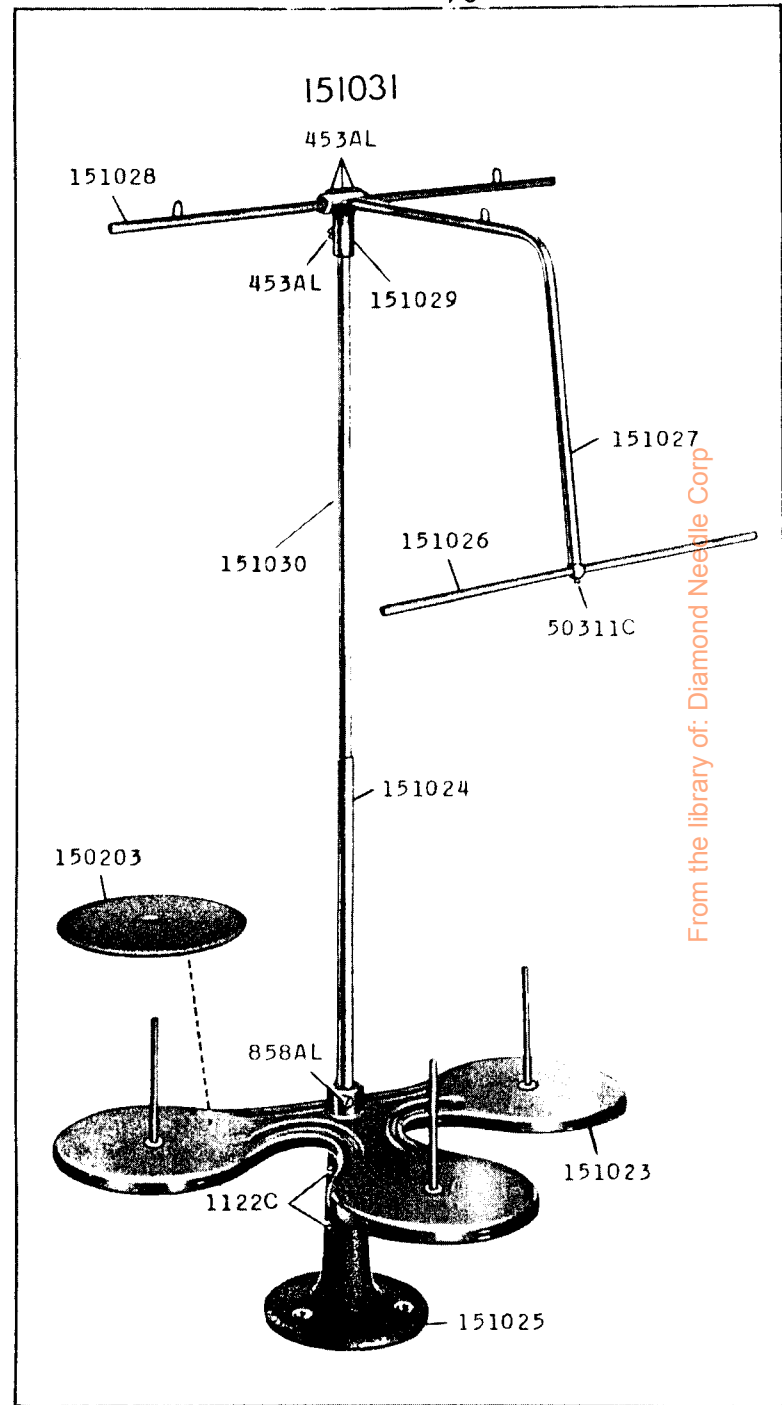

From the library of: Diamond Needle Corp







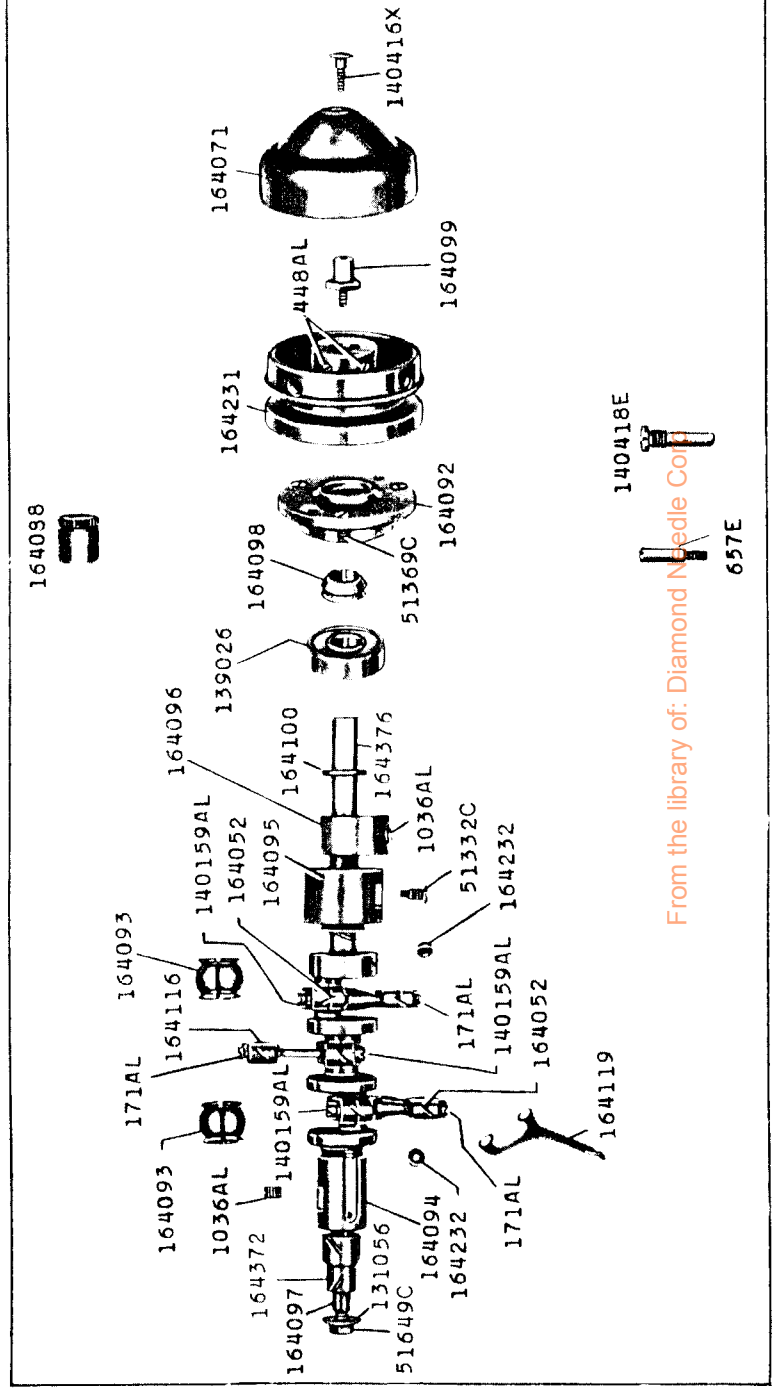
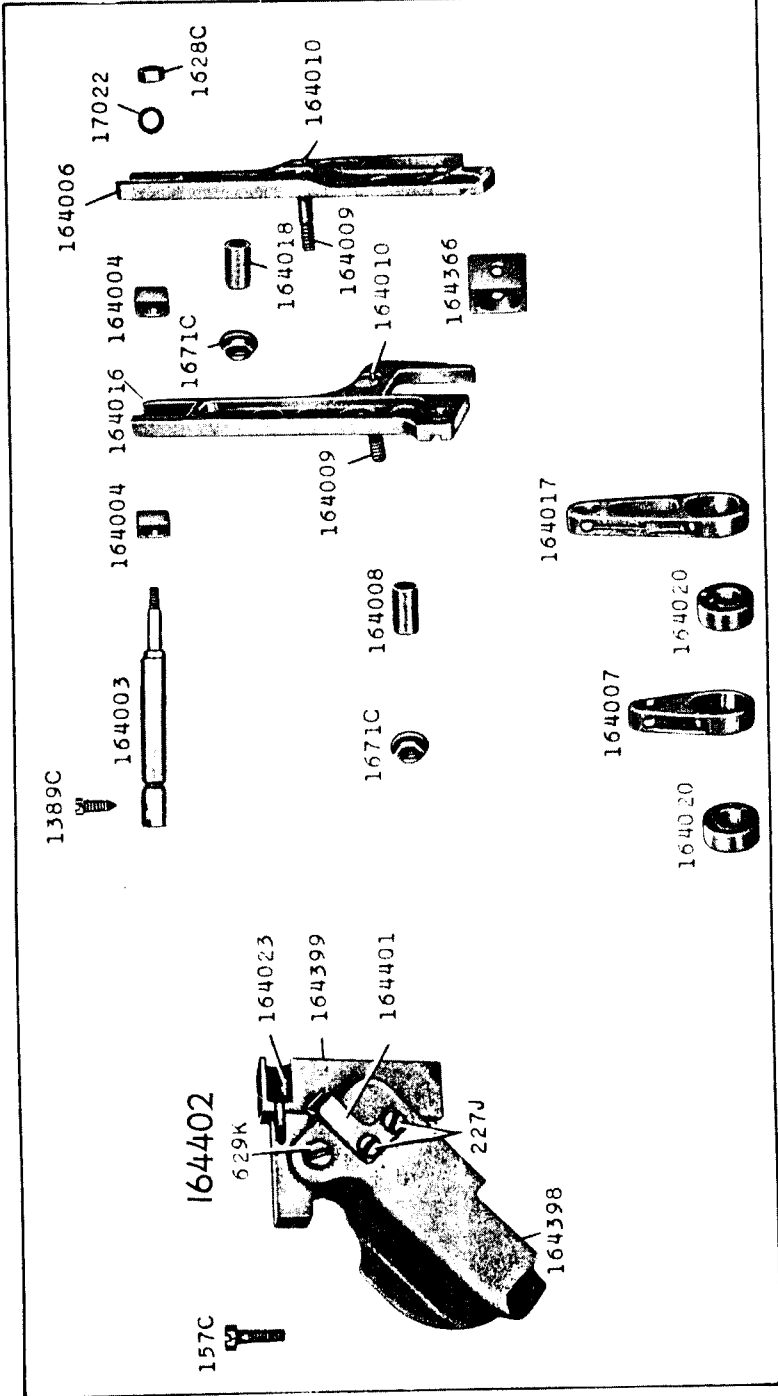

From the library of: **Diamond Needle Co.**  
140418E  
657E



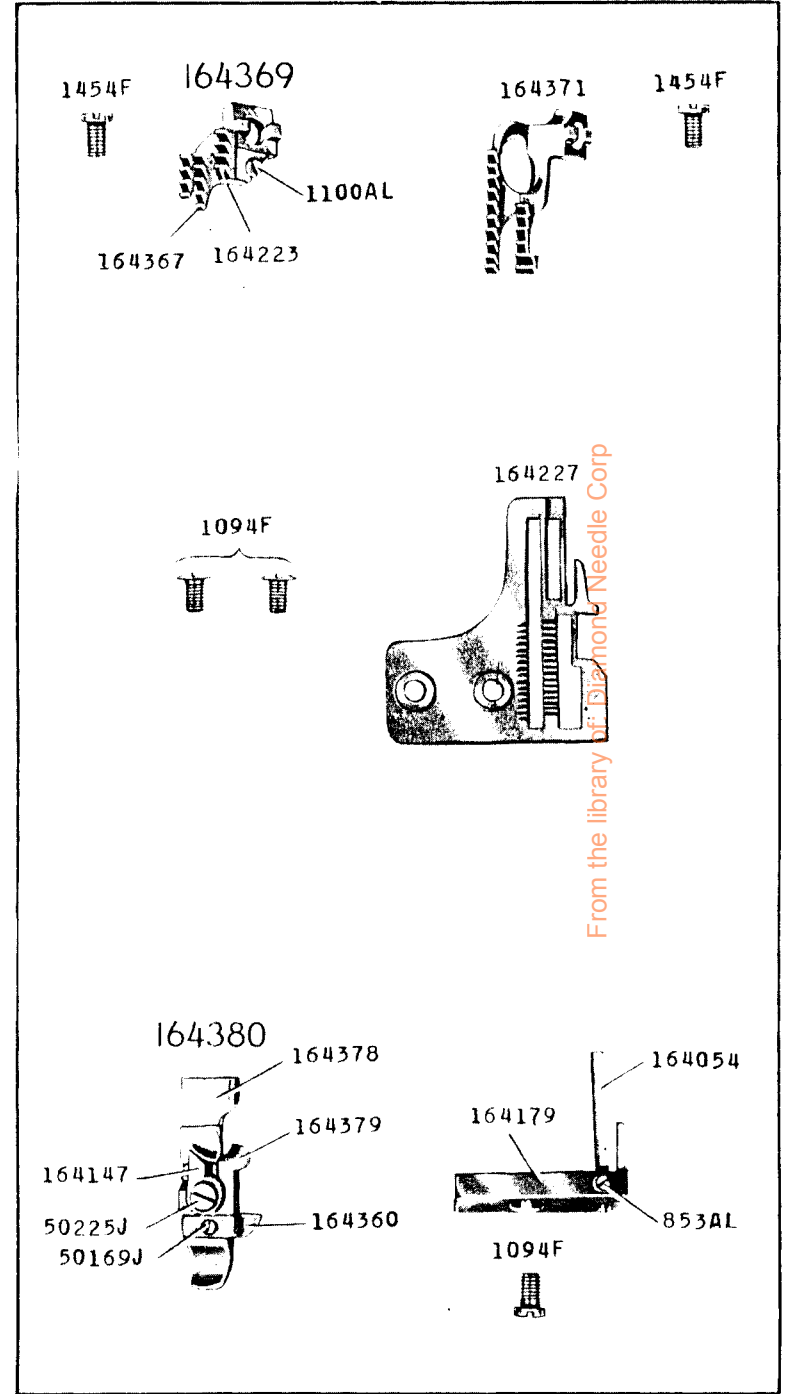
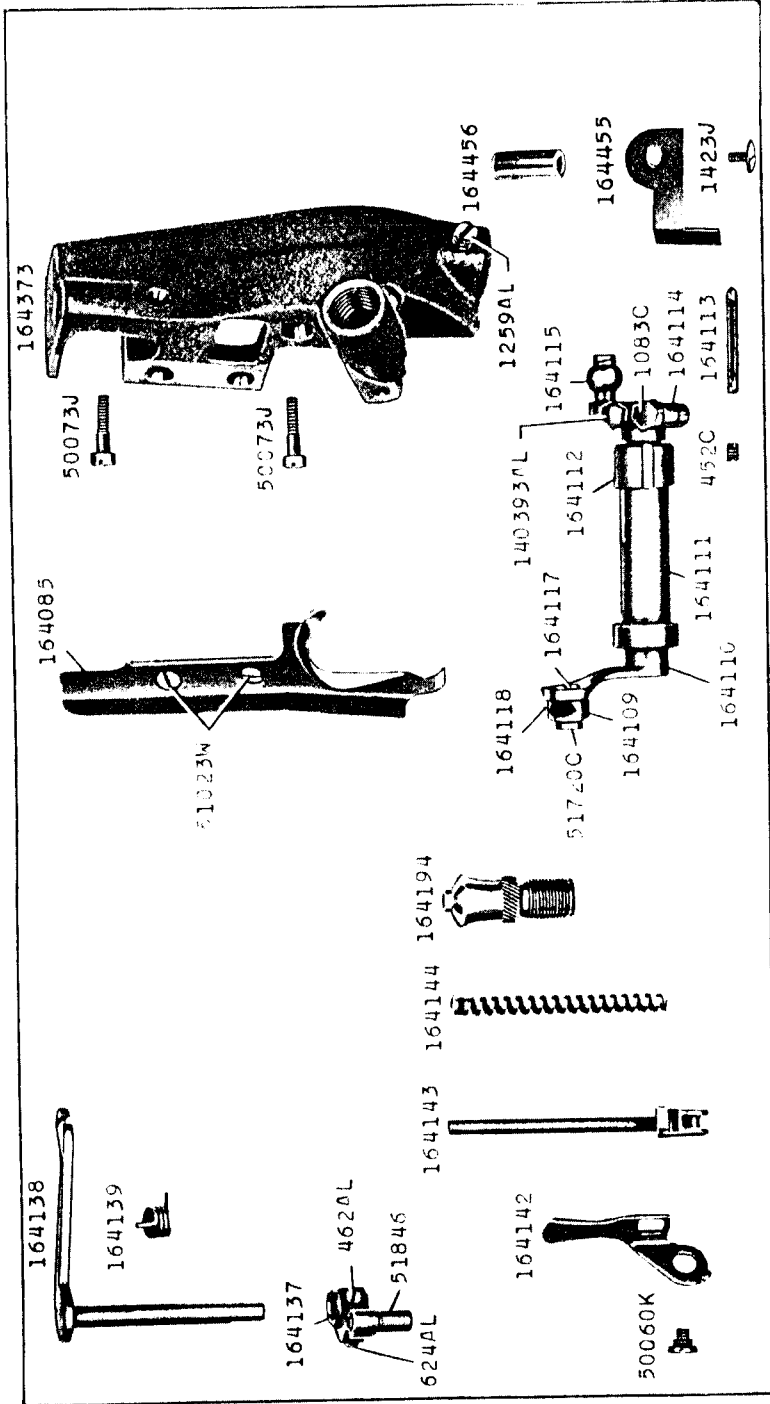

From the library of Diamond Needle Corp

24795 - 2/3

164391

164369

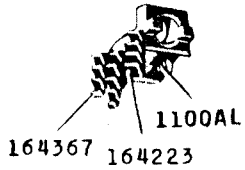

164371



164227

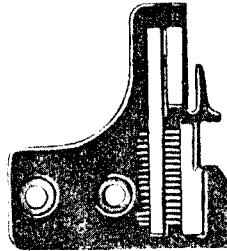

164380

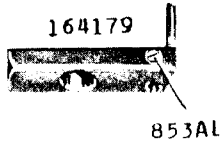
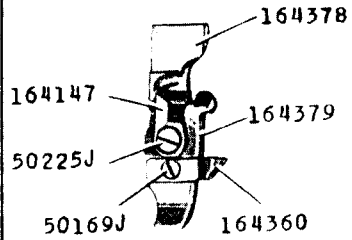

164350



164375



164151



164175



164091



24796 - 1/2

120344

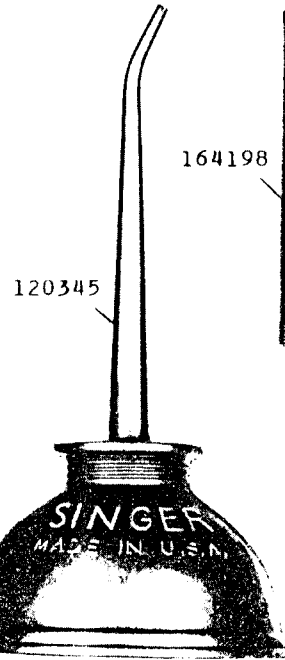

164198



164197



164196

164203



160577

26026



8908



64460



164204

From the library of: Diamond Needle Corp.